



YOUFA STEEL PIPE GROUP

TOP 500 ENTERPRISES OF CHINA INDUSTRY LEADING BRANDS

ADD: Floor 7, NO 4 Anshun Building, Dafeng Road(Aqua city).
Hongqiao Distr., Tianjin City, China 300120

www.youfasteelpipe.com / www.chinayoufa.com



TIANJIN YOUFA INTERNATIONAL TRADE CO., LTD



YOUFA STEEL PIPE GROUP

STOCK CODE: 601686

Listed enterprises on the main board of the Shanghai Stock Exchange

Youfa is the strongest welded steel pipe manufacturing group around China.



Brand "YOUFA" is the leading and outstanding brand in the industry.



Brand ZHENGJINYUAN is the growing champion in the industry.



01-04	集团及企业简介 Group & Company Introduction
05-09	盘扣式脚手架 Ringlock Scaffolding System
10-15	门式脚手架 Frame Scaffolding System
16-18	香蕉式脚手架 Kwikstage Scaffolding System
19-20	碗扣式脚手架 Cuplock Scaffolding System
21	轮扣式脚手架 Quick Lock Scaffolding System
22	脚手架踏板 Scaffolding Plank
23-24	钢支撑 Steel Prop / Shoring Post
25	可调丝杠底座和U型托 Adjustable Jack Base and U Head
26	脚手架扣件 Scaffolding Coupler
27	模板配件 Formwork Accessories
28	木材模板 Timber Formwork
29	工字梁模板 H Beam Formwork
30	铝梁 Aluminum Beam
31-32	铝制梯子 Aluminum Ladder
33-34	铝塔 Aluminum Tower
35	友发国贸员工合影及友发文化 Photo of Youfa International Trade Staff & Youfa Group Culture

Profile of the Group

Tianjin Youfa Steel Pipe Group Co., Ltd. was established on July 1, 2000, and its headquarters is located in Tianjin Daqiu Zhuang Town, the largest steel pipe production base in China. The company is a large scale steel pipe manufacturing enterprise integrating the production of various pipe products such as ERW steel pipe, spiral welded pipe, hot-dip galvanized steel pipe, plastic lining composite pipe, plastic coated steel pipe, square and rectangular steel pipe, hot-dip galvanized square and rectangular steel pipe, stainless Steel Pipe, pipe fitting and scaffolding, etc. Output is over 10 million tons every year.

In addition to its headquarters in Tianjin, the company currently has a number of subsidiaries in Tangshan, Handan, Shaanxi, Liyang and other cities, with more than 9000 employees, 293 production lines of steel pipe and scaffolding, 3 national accreditation laboratories and 2 Tianjin accreditation enterprise technology centers. In 2020, the annual sales of Youfa steel pipes will be nearly 12 million tons. By the end of 2017, the whole group had 88 utility model patents and 4 invention patents. There are 32 patents in the process of application and acceptance. Since 2010, Youfa's steel pipe production and sales have increased by more than one million tons annually for 11 consecutive years.

The "Youfa" was recognized as a well known trademark in China by the Trademark Office of the State Administration for Industry and Commerce in March 2008. Youfa Group products have been awarded the title of "Tianjin Famous-brand Products" by the Tianjin Municipal Government for many consecutive years. The steel pipes of "Youfa" brand and "Zhengjinyuan" brand won the Gold Cup Award, the highest award in China's metallurgical industry. Until 2021, Tianjin Youfa Steel Pipe Group has been among the top 500 Chinese enterprises, the top 500 Chinese manufacturing

enterprises and the top 500 Chinese private enterprises for 16 consecutive years, and has maintained its leading position in the industry in terms of national production and sales volume for 16 consecutive years.

"Youfa" brand steel pipes sell well all over the country and are widely used in key national projects such as Three Gorges Project, Capital International Airport, Shanghai Pudong International Airport, the 2008 Olympic Games venues, and 2010 Shanghai World Expo exhibition hall. They are exported to 100 countries and regions in European Union, North America, South America, Africa, South-east Asia, and the Middle East. They are recognized by the industry as the first brand in the industry, with a domestic comprehensive market share of more than 30%.

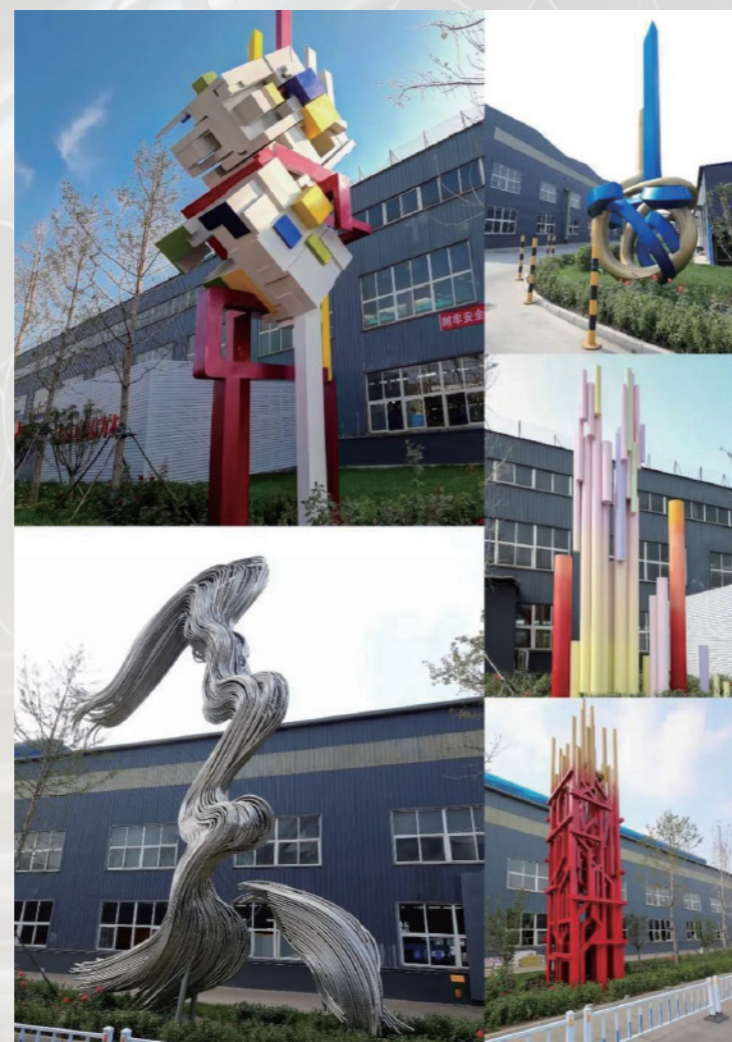

Tianjin Youfa Steel Pipe Factory

Production Base	Factory Name	Products Name	Production Lines	
Tianjin Production Base	Tianjin Youfa Steel Pipe Group Co.,Ltd.-No.1 Branch Company;	Hot Dipped Galvanized Steel Pipe	16	
		ERW Steel Pipe	9	
	Tianjin Youfa Steel Pipe Group Co.,Ltd.-No.2 Branch Company;	ERW Steel Pipe	7	
		Square/Rectangular Steel Pipe	15	
	Tianjin Youfa Dezhong Steel Pipe Co.,Ltd;	Galvanized Square/Rectangular steel Pipe	6	
		SSAW Steel Pipe	5	
	Tianjin Youfa Pipeline Technology Co.,Ltd;	Steel Pipe of Lining Plastic	10	
		Plastic Coated Steel Pipe	3	
	Tianjin Youfa Ruida Traffic Facilities Co.,Ltd	Highway Materials	9	
	Tianjin Youfa Stainless Steel Pipe Co., Ltd;	Stainless Steel Pipe	10	
		Stainless Steel Pipe Fitting	5	
	Tangshan Production Base	Tangshan Zhengyuan Pipeline Industry Co., Ltd.;	Hot Dipped Galvanized Steel Pipe	12
ERW Steel Pipe			17	
Steel Pipe of Lining Plastic			4	
Tangshan Youfa Steel Pipe Manufacture Co.,Ltd;		ERW Steel Pipe	11	
		ERW Steel Pipe	11	
Tangshan Youfa New Building Equipment Co., Ltd		Galvanize	12	
		Ringlock Scaffolding System	9	
Handan Production Base		Handan Youfa Steel Pipe Co.,Ltd;	Hot Dipped Galvanized Steel Pipe	8
			ERW Steel Pipe	12
			Square/Rectangular Steel Pipe	13
	Galvanized Square/Rectangular Steel Pipe		4	
	SSAW Steel Pipe		4	
Shaanxi Production Base	Shaanxi Youfa Steel Pipe Co.,Ltd;	Steel Pipe of Lining Plastic	4	
		Hot Dipped Galvanized Steel Pipe	6	
		ERW Steel Pipe	12	
		Square/Rectangular Steel Pipe	6	
		Galvanized Square/Rectangular Steel Pipe	3	
Liyang Production Base	Jiangsu Youfa Steel Pipe Co.,Ltd;	Steel Pipe of Lining Plastic	3	
		Plastic Coated Steel Pipe	3	
		Hot Dipped Galvanized Steel Pipe	6	
		ERW Steel Pipe	10	
Huludao City Steel Pipe Industrial Co.,Ltd;	Chengdu Yunganglian Logistics Co.,Ltd;	Square/Rectangular Steel Pipe	9	
		Galvanized Square/Rectangular Steel Pipe	4	
		Welded Steel Oil Pipe	15	
		Logistics Centre		
Total			293	



TIANJIN YOUFA PRODUCTION BASE



TANGSHAN YOUFA PRODUCTION BASE



HANDAN YOUFA PRODUCTION BASE



SHAANXI YOUFA PRODUCTION BASE



LIYANG YOUFA PRODUCTION BASE



HULUDAO YOUFA PRODUCTION BASE

Tianjin Youfa Steel Pipe Project

Year	Country	Project	Usage
2014-2015	-	Chevron Corporation Oil Platform	Scaffolding steel pipe
2015	Ethiopia	Adama Industrial Parks	Construction steel pipe
2017	Jordan	Mafrac	Solar mounting systems steel pipe
2017	Mexico	Kaixo	Solar mounting systems steel pipe
2018	Viet Nam	Cong ty TNHH Gain Lucky Textile Factory	Solar mounting systems steel pipe
2019	Kuwait	Kuwait International Airport	Construction steel pipe
2019	Ethiopia	Polaroid Airport	Conduit steel pipe
2019	Egypt	New Cairo Business Center	Fire sprinkler and water delivery steel pipe



Galvanized Steel Pipe used in ADAMA INDUSTRIAL PARK PROJECT in ETHIOPIA



Scaffolding Steel Pipes used in Chevron Corporation Oil Platform

Core member of national important industry association



Tangshan Youfa New Type Construction Equipment Co., Ltd.

Tangshan Youfa New Type Construction Equipment Co., Ltd., a key construction project in Hebei Province, was founded in June 2020. It is built by Tianjin Youfa Steel Pipe Group Co., LTD., who is China's top 500 enterprises and listed company on the main board, with an investment of 3.4 billion CNY in three phases. Covering an area of 927,000 m². The company annually produces 3 million tons of new building materials and 4.4 million tons of various high quality pipes, such as scaffolding pipes and solar mounting systems pipes, realizing sales revenue of 10 billion CNY and providing more than 6,000 jobs. It is a large ringlock scaffolding production base in China and even the world. Company located in the hinterland of the coordinated development

of Beijing-Tianjin-Hebei economic core, coastal high-speed, Hainan railway, Tianjin port, Caofeidian port as the hub, formation water transport logistics transportation network. The company products rapid radiation the Beijing and Tianjin, North China and even the whole country, and exported to North America, Europe, Southeast Asia, more than 100 countries and regions, has a stable international market. As the largest independent steel deep processing enterprise in the region, we have the industry's only full process production line, raw materials are mainly purchased from large local high quality steel enterprises. Professional product logistics fleet, to achieve 24 hours of one-stop service.



RINGLOCK SCFFOLDING SYSTEM



Standard : AS/NZS1576.3:2015

Advantage :

Safety : Ringlock standards are assembled with ledgers and diagonal braces using secure fixed wedge connections , It enhance the safety and stability of the system.

Economic : Easily assembled system scaffold saves time and labor costs.

Application : Ringlock scaffolding is widely used in many construction projects, such as Civil & Building, interior decoration,stage erection, bridge construction, etc.

Two Normal types :



inner spigot



outer sleeve spigot

60 system standard

Material : Q355 Steel

Surface treatment:Hot dipped galvanized

Dimensions : $\Phi 60 \times 3.25\text{mm}$

Effective length : 500/ 1000/ 1500/ 2000/ 2500/ 3000 mm

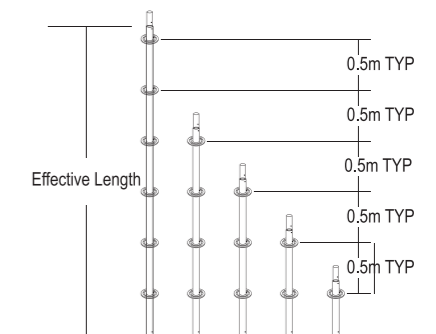

Ringlock standard/ vertical with spigot

Material : Q355 Steel

Surface treatment : Hot dipped galvanized

Dimensions : $\Phi 48.3 \times 3.25\text{mm}$

Item No.	Length	Theoretic Weight
YFRS48 050	0.5 m / 1'7"	3.2 kg / 7.04 lbs
YFRS48 100	1.0 m / 3'3"	5.5 kg / 12.1 lbs
YFRS48 150	1.5 m / 4'11"	7.8 kg / 17.16 lbs
YFRS48 200	2.0 m / 16'6"	10.1 kg / 22.22 lbs
YFRS48 250	2.5 m / 8'2"	12.4 kg / 27.28 lbs
YFRS48 300	3.0 m / 9'9"	14.6 kg / 32.12 lbs



Ringlock ledger/ horizontal

Material : Q235 Steel

Surface treatment : Hot dipped galvanized

Dimensions : $\Phi 48.3 \times 3.2/3/2.75/2.5$ mm or customized by customer

Popular Sizes for European market

Item No.	Length
YFRL48 039	0.39 m / 1'3"
YFRL48 050	0.50 m / 1'7"
YFRL48 073	0.732 m / 2'5"
YFRL48 109	1.088 m / 3'7"
YFRL48 129	1.286 m / 4'3"
YFRL48 140	1.40 m / 4'7"
YFRL48 157	1.572 m / 5'2"
YFRL48 207	2.072 m / 6'9"
YFRL48 257	2.572 m / 8'5"
YFRL48 307	3.07 m / 10'4"



Popular Sizes for South East Asia and Africa market.

Item No.	Length
YFRL48 060	0.6 m / 1'11"
YFRL48 090	0.9 m / 2'11"
YFRL48 120	1.2 m / 3'11"
YFRL48 150	1.5 m / 4'11"
YFRL48 180	1.8 m / 5'11"
YFRL48 210	2.1 m / 6'6"
YFRL48 240	2.4 m / 7'10"

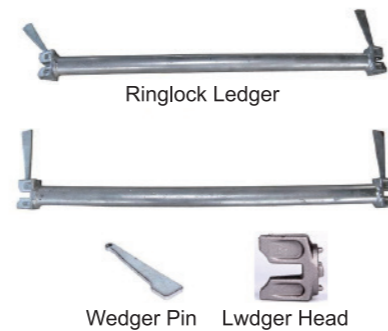

Popular Sizes for Singapore market.

Item No.	Effective Length
YFRL48 061	0.61 m / 2'
YFRL48 091	0.914 m / 3'
YFRL48 121	1.219 m / 4'
YFRL48 152	1.524 m / 5'
YFRL48 182	1.829 m / 6'
YFRL48 213	2.134 m / 7'
YFRL48 243	2.438 m / 8'
YFRL48 304	3.048 m / 10'



Ringlock diagonal brace / Bay braces

Material : Q235 or Q195 steel / Surface treatment:Hot dipped galvanized

Dimensions : $\Phi 48.3 \times 2.75$ or customized by customer

Item No.	Bay Length	Bay Width	Theoretic Weight
YFDB48 060	0.6 m	1.5 m	3.92 kg
YFDB48 090	0.9 m	1.5 m	4.1 kg
YFDB48 120	1.2 m	1.5 m	4.4 kg
YFDB48 150	1.5 m	1.5 m	6.63 kg
YFDB48 065	0.65 m / 2'2"	2.07 m	7.35 kg / 16.2 lbs
YFDB48 088	0.88 m / 2'10"	2.15 m	7.99 kg / 17.58 lbs
YFDB48 115	1.15 m / 3'10"	2.26 m	8.53 kg / 18.79 lbs
YFDB48 157	1.57 m / 8'2"	2.18 m	9.25 kg / 20.35 lbs

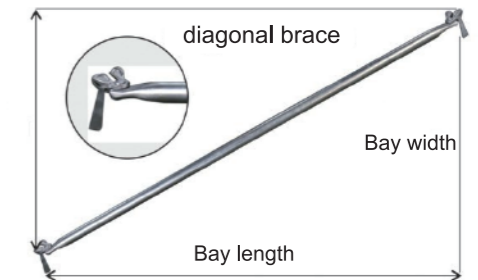

Double / Truss / bridge /Reinforce ledger

Material : Q235 Steel / Surface treatment:Hot dipped galvanized

Dimensions : $\Phi 48.3 \times 2.75$ mm or customized by customer

Item No.	Length	Weight
YFTL48 157	1.57 m / 5'2"	10.1 kg / 22.26 lbs
YFTL48 213	2.13 m / 7'	16.1 kg / 35.43 lbs
YFTL48 305	2.13 m / 10'	24 kg / 52.79 lbs



Intermediate Transom

Q235 Hot dip galvanized 48.3*3 mm

Item No.	Length	Weight
YFIT48 115	1.15 m / 3'10"	5.36 kg / 11.78 lbs
YFIT48 213	2.13 m / 7'	8.91 kg / 19.6 lbs
YFIT48 305	3.05 m / 10'	12.2 kg / 26.85 lbs

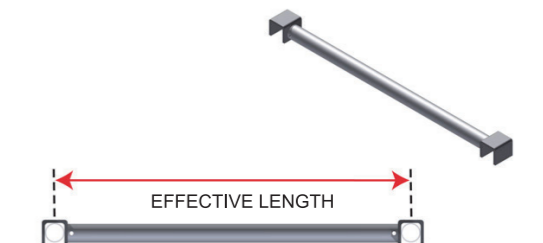

Trussed Beam/ Lattice Girder

Q235 Hot dip galvanized 48.3*3 mm

Item No.	Length	Weight
YFTB48 517	5.17 m / 17'	70.47 kg / 115.03 lbs
YFTB48 614	6.14 m / 20'2"	82.63 kg / 181.79 lbs
YFTB48 771	7.71 m / 25'3"	103.76 kg / 228.26 lbs

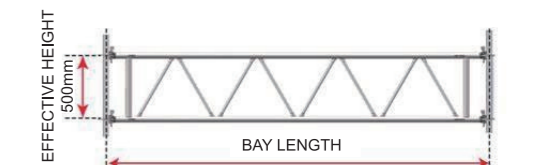

Side bracket / board bracket

Finished : Hot dipped galvanized / Dimension: 48.3*3 mm /Material:Q235

Item No.	Length	Weight
YFSB48 065	0.65 m / 2'2"	6.61 kg / 214.54 Ibs
YFSB48 088	0.88 m / 2'10"	8.62 kg / 18.96 Ibs



Base collar

Surface treatment : Hot dipped galvanized

Item No.	Dimension	Length
YFBC48 024	Q235, Φ48.3*3mm	0.24 m / 9.4"
YFBC48 030	Q235, Φ48.3*3mm	0.30 m / 11.8"
YFBC48 028	Q345, Φ57*3.5mm	0.28 m / 11"
YFBC48 037	Q345, Φ70*3.5mm	0.37 m / 14.57"



Ringlock accessories



Ringlock rosette



Ringlock ledger head



Ringlock brace end



Ringlock pins



Twin Wedge Coupler



Spigot



scaffold basket



scaffold rack

Frame scaffolding system

Standard : ANSI/SSFI SC100-5/05

Finishing : Pre - galvanized or painted

Advantages :

1. Easily assembled
2. Fast erection and dismantling
3. High-strength steel tubing
4. Safe, efficient and dependable

American frame

Walk thru frame

Item No.	Width	Height	Weight
YFAFW 1519	1524 mm/ 5'	1930.4 mm/ 5'4"	21.45 kg / 47.25 Ibs
YFAFW 0919	914.4 mm/ 3'	1930.4 mm/ 6'4"	18.73 kg / 41.25 Ibs
YFAFW 1520	1524 mm/ 5'	2006.6 mm/ 6'7"	22.84 kg / 50.32 Ibs
YFAFW 0920	914.4 mm/ 3'	2006.6 mm/ 6'7"	18.31 kg / 43.42 Ibs
YFAFW 1019	1066.8 mm/ 42"	1930.4 mm/ 6'4"	19.18 kg / 42.24 Ibs

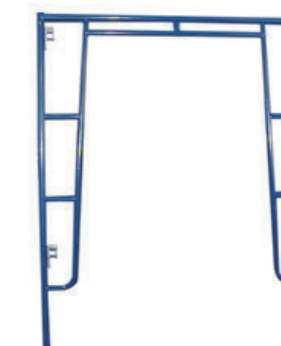

Walk thru - Apartment frame(OD: 1.625 ")

Item No.	Width	Height	Weight
YFAFA 0926	914.4 mm/ 3'	2641.6 mm/ 8'8"	21.34 kg / 47 Ibs
YFAFA 0932	914.4 mm/ 3'	3251.2 mm/ 10'8"	25.22 kg / 55.56 Ibs
YFAFA 0935	914.4 mm/ 3'	3556 mm/ 11'8"	26.51 kg / 58.4 Ibs

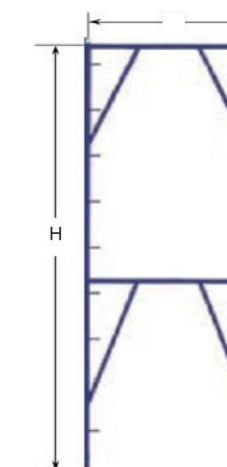

Walk thru - Apartment frame with 18" ladder (OD: 1.625 ")

Item No.	Width	Height	Weight
YFAFL 0926	914.4 mm/ 3'	2641.6 mm/ 8'8"	21.34 kg / 47 Ibs
YFAFL 0932	914.4 mm/ 3'	3251.2 mm/ 10'8"	37.07 kg / 81.65 Ibs
YFAFL 0935	914.4 mm/ 3'	3556 mm/ 11'8"	40 kg / 88.11 Ibs

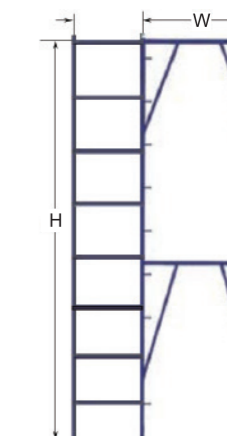

Mason frame(OD : 1.69")

Item No.	Width	Height	Weight
YFAFM 1519	1524 mm/ 5'	1930.4 mm/ 6'4"	20.43 kg / 45 lbs
YFAFM 1515	1524 mm/ 5'	1524 mm/ 5'	16.87 kg / 37.15 lbs
YFAFM 1512	1524 mm/ 5'	1219.2 mm/ 4'	15.30 kg / 33.7 lbs
YFAFM 1509	1524 mm/ 5'	914.4 mm/ 3'	12.53 kg / 27.6 lbs
YFAFM 1506	1524 mm/ 5'	609.6 mm/ 2'	11.31 kg / 24.91 lbs

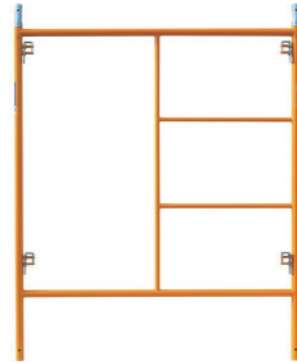

Box frame

Item No.	Width	Height	Weight
YFAFB 1505	1524 mm/ 5'	508 mm/ 20"	10.41 kg / 22.92 lbs
YFAFB 0905	914.4 mm/ 3'	508 mm/ 20"	7.70 kg / 16.97 lbs
YFAFB 1510	1524 mm/ 5'	1016 mm/ 40"	12.91 kg / 28.43 lbs
YFAFB 0910	914.4 mm/ 3'	1016 mm/ 40"	10.71 kg / 23.58 lbs

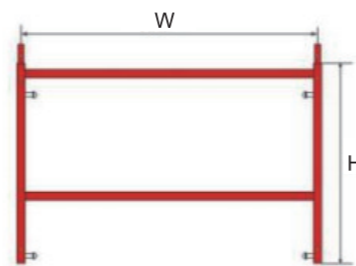

Double box frame

Item No.	Width	Height	Weight
YFAFDB 1520	1524 mm/ 5'	2032 mm/ 6'8"	24.47 kg / 53.24 lbs
YFAFDB 1515	1524 mm/ 5'	1524 mm/ 5'	19.40 kg / 42.73 lbs



Narrow frame/ ladder frame (OD : 1.69")

Item No.	Width	Height	Weight
YFAFN 0919	914.4 mm/ 3'	1930.4 mm/ 6'4"	16.00 kg / 35.24 lbs
YFAFN 0915	914.4 mm/ 3'	1524 mm/ 5'	14.41 kg / 31.75 lbs
YFAFN 0909	914.4 mm/ 3'	914.4 mm/ 3'	10.15 kg / 22.36 lbs
YFAFN 0615	609.6 mm/ 2'	1524 mm/ 5'	11.67 kg / 25.7 lbs
YFAFM 0609	609.6 mm/ 2'	914.4 mm/ 3'	7.81 kg / 17.2 lbs



Snap on Cross Braces

Item No.	A	B	C	Weight
YFSOCB 1508	1524 mm/ 5'	812.8 mm/ 32"	1727.2 mm/ 5'8"	4.36 kg / 9.6 lbs
YFSOCB 1512	1524 mm/ 5'	1219.2 mm/ 48"	1955.8 mm/ 6'5"	4.50 kg / 9.92 lbs
YFSOCB 2108	2133.6 mm/ 7'	812.8 mm/ 32"	2159 mm/ 7'1"	5.60 kg / 12.34 lbs
YFSOCB 2112	2133.6 mm/ 7'	1219.2 mm/ 48"	2463.8 mm/ 8'1"	5.70 kg / 12.56 lbs
YFSOCB 3008	3048 mm/ 10'	812.8 mm/ 32"	3149.6 mm/ 10'4"	7.50 kg / 16.53 lbs
YFSOCB 3012	3048 mm/ 10'	1219.2 mm/ 48"	3276.6 mm/ 10'9"	7.81 kg / 17.2 lbs

Punch hole Cross Braces

Item No.	A	B	C	Weight
YFPHCB 1512	1524 mm/ 5'	1219.2 mm/ 4'	1951.74 mm/ 76.84"	4.75 kg / 10.47 lbs
YFPHCB 1509	1524 mm/ 5'	914.4 mm/ 3'	1777.24 mm/ 69.97"	4.04 kg / 8.9 lbs
YFPHCB 2112	2133.6 mm/ 7'	1219.2 mm/ 4'	2457.45 mm/ 96.75"	5.82 kg / 12.83 lbs
YFPHCB 2109	2133.6 mm/ 7'	914.4 mm/ 3'	2321.31 mm/ 91.39"	5.63 kg / 12.4 lbs
YFPHCB 3012	3048 mm/ 10'	1219.2 mm/ 4'	3282.7 mm/ 129.24"	7.85 kg / 17.3 lbs
YFPHCB 3009	3048 mm/ 10'	914.4 mm/ 3'	3182.1 mm/ 125.28"	7.63 kg / 16.8 lbs

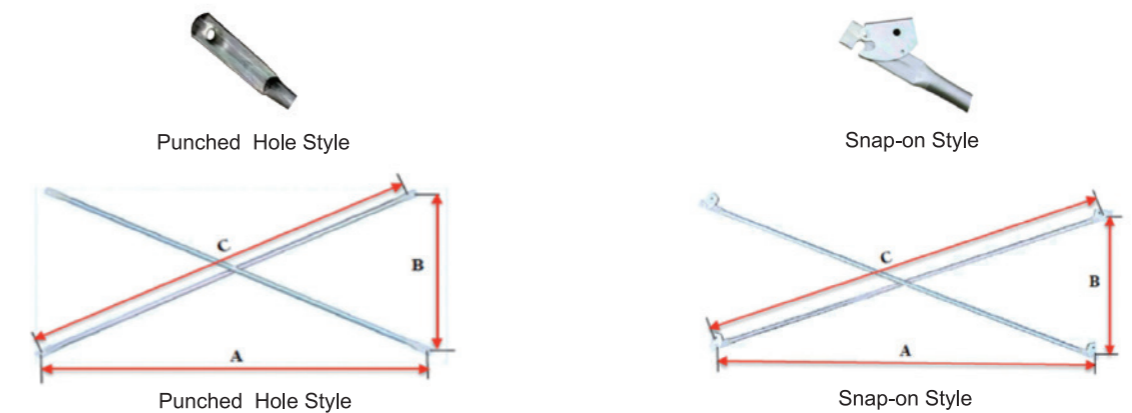

Punch hole Guard Rail

Item No.	Length	Tube OD	Weight
YFPHGR 3002	3048 mm/ 10'	25.4 mm/ 1"	4.84 kg / 10.65 lbs
YFPHGR 2102	2133.6 mm/ 7'	25.4 mm/ 1"	3.27 kg / 7.2 lbs
YFPHGR 1802	1828.8 mm/ 6'	25.4 mm/ 1"	2.20 kg / 4.85 lbs
YFPHGR 1502	1524 mm/ 5'	25.4 mm/ 1"	1.85 kg / 4.08 lbs
YFPHGR 1202	1219.2 mm/ 4'	25.4 mm/ 1"	1.50 kg / 3.3 lbs
YFPHGR 0902	914.4 mm/ 3'	25.4 mm/ 1"	1.15 kg / 2.53 lbs



Snap on Guard Rail

Item No.	Length	Tube OD	Weight
YFSOGR 3003	3048 mm/ 10'	31.75 mm/ 1.25"	4.5 kg / 9.92 lbs
YFSOGR 2103	2133.6 mm/ 7'	31.75 mm/ 1.25"	3.8 kg / 8.37 lbs
YFSOGR 1503	1524 mm/ 5'	31.75 mm/ 1.25"	2.9 kg / 6.39 lbs
YFSOGR 0903	914.4 mm/ 3'	31.75 mm/ 1.25"	2.0 kg / 4.4 lbs



Guard Rail Post



Item No.	Description	Length	Tube OD	Length
YFGRP 1301	Snap-On Guard Rail Post with Tail	1320.8 mm/ 52"	41.275 mm/ 1.625"	3.5 kg / 7.7 lbs
YFGRP 1302	Guard Rail Post with Tail, Flip Lock	1320.8 mm/ 52"	42.926 mm/ 1.69"	3.5 kg / 7.72 lbs
YFGRP 1101	Guard Rail Line Post Female, Flip Lock	1143 mm/ 45"	41.275 mm/ 1.625"	2.82 kg / 6.22 lbs
YFGRP 1102	Guard Rail Post Female, Flip Lock	1143 mm/ 45"	41.275 mm/ 1.625"	2.95 kg / 6.5 lbs
YFGRP 1001	Guard Rail Post Female, Flip Lock	1073.15 mm/ 42.25"	42.926 mm/ 1.69"	2.81 kg / 6.18 lbs
YFGRP 1401	Guard Rail Post with Tail, with W Lock	1422.4 mm/ 56"	41.275 mm/ 1.625"	3.92 kg / 8.63 lbs
YFGRP 1103	Guard Rail Post Female, with W Lock	1117.6 mm/ 44"	42.926 mm/ 1.69"	3.5 kg / 7.71 lbs

Frame scaffolding accessories

Lock Options



Lock Pins

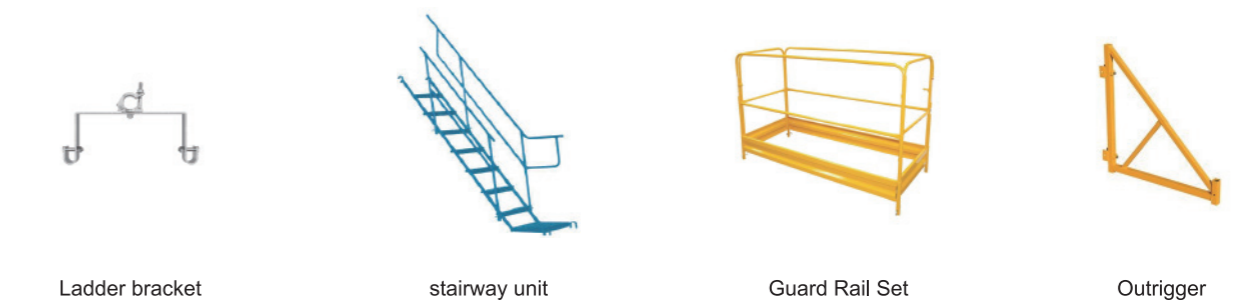
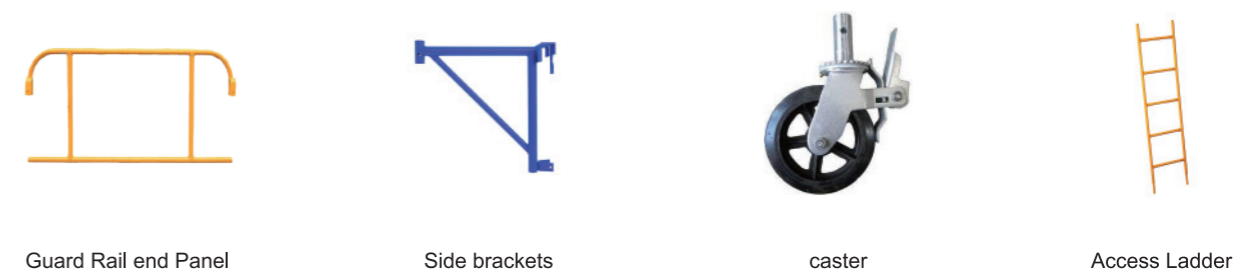

Main frame

Material : Q195 & Q235 Steel Strip Surface treatment : Pre- galvanized or painted

Outer tube : $\phi 42 \times 2$ mm Inner tube : 25×1.5 mm

Wlak through frame / H frame

Item No.	Dimension(W*H)	Weight
YFHF 1219	1219*1930 mm	14.3 kg
YFHF 1217	1219*1700 mm	12.8 kg
YFHF 1215	1219*1524 mm	11.4 kg
YFHF 0919	914*1930 mm	13.4 kg
YFHF 0917	914*1700 mm	12.3 kg

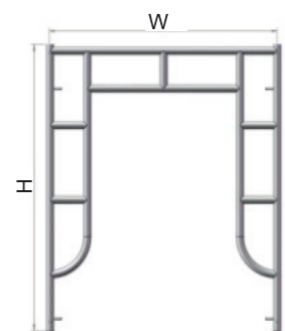

Mason frame/ ladder frame

Item No.	Dimension(W*H)	Weight
YFHF 1219	1219*1930 mm	15.2 kg
YFHF 1217	1219*1700 mm	13.5 kg
YFHF 1215	1219*1524 mm	10.82 kg
YFHF 0919	1219*914 mm	8.7 kg
YFHF 0917	914*1524 mm	10.9 kg

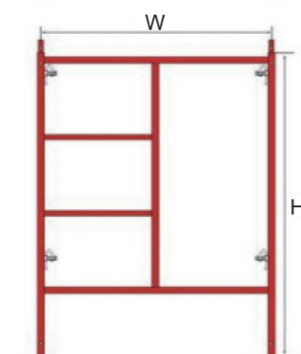

Cross brace

Diameter : 22 mm Wall thickness : 0.8mm/1mm, or customized by customer Material : Q195

Item No.	A	B	C
YFCB 1215	1219 mm	1524 mm	1952 mm
YFCB 1212	1219 mm	1219 mm	1724 mm
YFCB 1218	1219 mm	1829 mm	2198 mm
YFCB 0912	914 mm	1219 mm	1524 mm
YFCB 1912	914 mm	1829 mm	2045 mm
YFCB 0612	610 mm	1219 mm	1363 mm
YFCB 1912	1524 mm	914 mm	1777 mm
YFCB 1912	1829 mm	610 mm	1928 mm

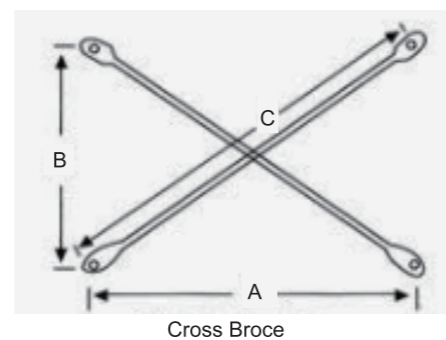

Stair case

Item No.	Width*	Length	Height	Weight
YFFSC 041819	450*2677 mm	1829 mm	1955 mm	25.55 kg
YFFSC 041520	450*2370 mm	1500 mm	2000 mm	23.31 kg
YFFSC 101819	1000*2690.7 mm	1800 mm	2000 mm	52.02 kg
YFFSC 102020	1000*2828 mm	2000 mm	2000 mm	52.59 kg



KWIKSTAGE SCAFFOLDING SYSTEM

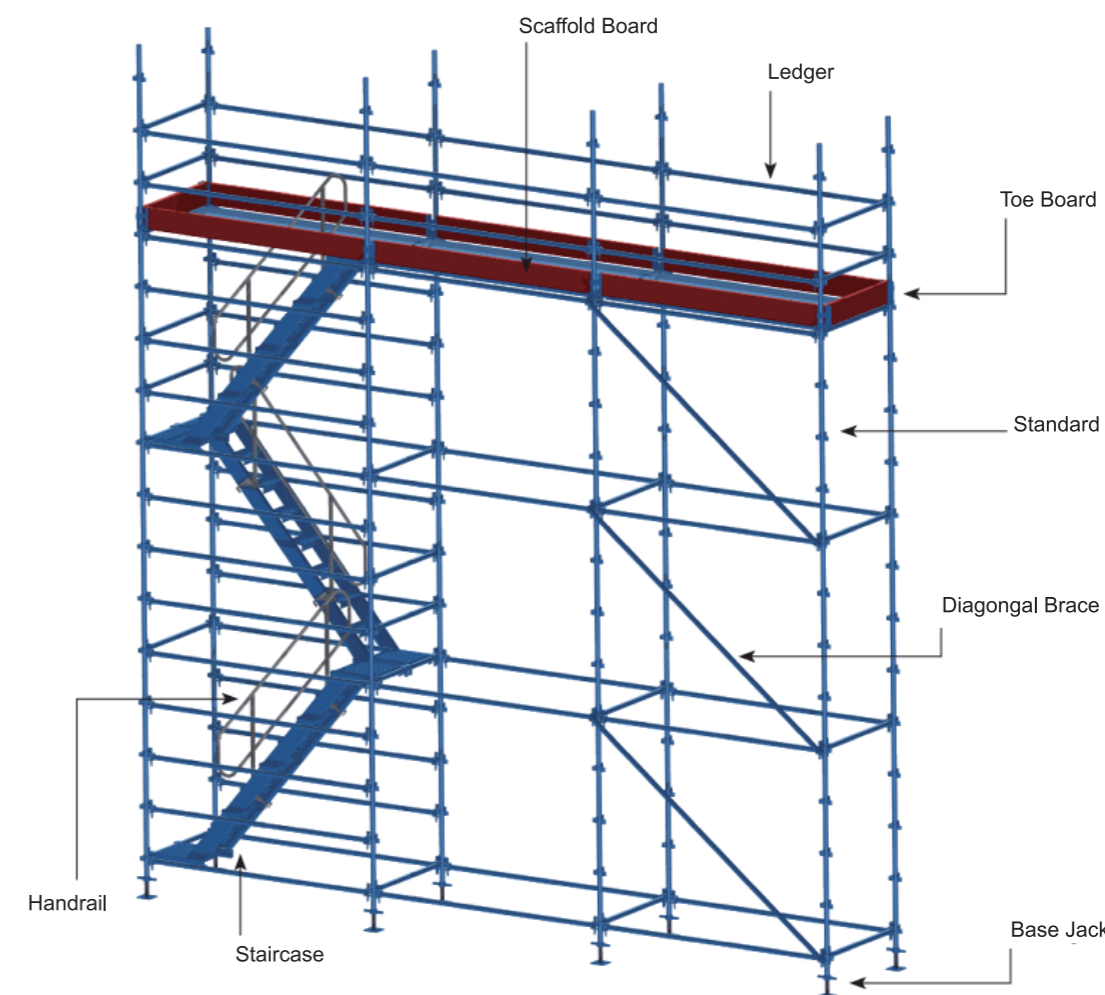

Kwikstage standard/ vertical

Standard: AS/NZS 1576 Material: Q235

Finishing: painted or galvanized Tube: $\Phi 48.3 \times 4$ mm

With "y" pressings in clusters at 495mm intervals

Item No.	Width*	Length
YFKS 300	3 m / 9'9"	17.2 kg / 37.84 lbs
YFKS 250	2 m / 8'1.5"	14.4 kg / 31.68 lbs
YFKS 200	2 m / 6'6"	11.7 kg / 25.77 lbs
YFKS 150	1.5 m / 4'10.5"	8.5 kg / 18.7 lbs
YFKS 100	1 m / 3'3"	6.2 kg / 13.64 lbs
YFKS 050	0.5 m / 1'7.5"	3 kg / 6.6 lbs

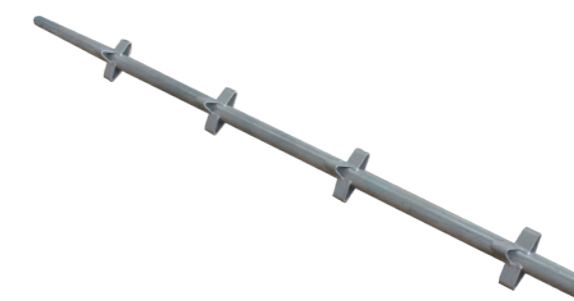

Kwikstage ledger/ Horizontal

Standard : AS/NZS 1576 **Material :** Q235

Finishing : painted or galvanized **Tube :** Φ48.3*3.25 mm

Fit into upper "v" pressings on standards

Item No.	Length	Weight
YFKL 300	3 m / 9'10"	12.5 kg / 27.56 Ibs
YFKL 240	2.4 m / 8'	9.2 kg / 20.24 Ibs
YFKL 180	1.8 m / 6'	7 kg / 15.4 Ibs
YFKL 120	1.2 m / 4'	5.6 kg / 12.32 Ibs
YFKL 070	0.7 m / 2'3.5"	3.85 kg / 8.49 Ibs
YFKL 050	0.5 m / 1'7.5"	3.45 kg / 7.61 Ibs



Kwikstage transom

Standard : AS/NZS 1576 **Material :** Q235 **Finishing :** painted or galvanized **Spec :** 50*50*5 mm

Fit into lower "V" pressings on standards Flanges provide seating for decking components

Item No.	Length	Weight
YFKL 240	2.4 m / 8'	21 kg / 46.3 Ibs
YFKL 180	1.8 m / 6'	15 kg / 33.07 Ibs
YFKL 120	1.2 m / 4'	9.8 kg / 21.6 Ibs
YFKL 070	0.7 m / 2'3.5"	5.8 kg / 12.79 Ibs
YFKL 050	0.5 m / 1'7.5"	4.5 kg / 9.92 Ibs



Kwikstage diagonal brace

Standard : AS/NZS 1576 **Material :** Q235

Finishing : painted or galvanized **Tube :** Φ48.3*2.5 mm

Fit into outside V" pressings on standard.

Item No.	Length	Weight
YFKL 320	3.2 m / 10'6"	13.4 kg / 29.54 Ibs
YFKL 270	2.7 m / 8'10.5"	11.5 kg / 25.35 Ibs
YFKL 200	2 m / 6'7"	8.6 kg / 18.96 Ibs
YFKL 170	1.7 m / 5'7"	8.6 kg / 18.52 Ibs



Kwikstage Tie Bar

Standard : AS/NZS 1576 **Material :** Q235 **Finishing :** painted or galvanized **Spec :** 40*40*4 mm

Steel angle with curved lugs at each end. Fit into 2 and 3 board platform brackets Used to prevent spreading of 2 and 3 board platform brackets.

Item No.	Length	Weight
YFKTB 240	2.4 m / 8'	7 kg / 15.43 Ibs
YFKTB 180	1.8 m / 6'	5.2 kg / 11.46 Ibs
YFKTB 120	1.2 m / 4'	3.5 kg / 7.72 Ibs
YFKTB 070	0.7 m / 2'3.5"	3.2 kg / 7.05 Ibs



Kwikstage steel plank

Standard : AS/NZS 1577 **Material :** Q235

Finish : galvanized **Spec :** W 225 mm*H 65mm*T 1.8mm

Item No.	Length	Weight
YFKP 240	2420 mm / 8'	14.94 kg / 32.95 Ibs
YFKP 180	1810 mm / 6'	11.18 kg / 24.66 Ibs
YFKP 120	1250 mm / 4'2"	7.7 kg / 16.98 Ibs
YFKP 070	740 mm / 2'6"	4.8 kg / 10.6 Ibs

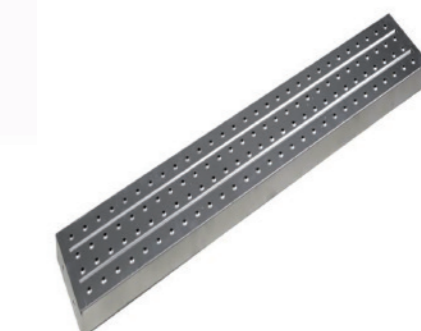

Return Transom



Ladder Access Transom



Mesh Panel / Brick Guard



Hop Up Bracket



Wall Tie



Toe Board Clip

CUPLOCK SCAFFOLDING SYSTEM

Standard : BS12811-2003 Finishing : Painted or hot dipped galvanized



Cuplock standard/ vertical (Material : Q235/ Q355 Spec : 48.3*3.2 mm)

Item No.	Length	Weight
YFCS 300	3 m / 9'10"	17.5 kg / 38.25 Ibs
YFCS 250	2.5 m / 8'2"	14.57 kg / 32.12 Ibs
YFCS 200	2 m / 6'2"	11.82 kg / 26.07 Ibs
YFCS 150	1.5 m / 4'11"	9.05 kg / 19.95 Ibs
YFCS 100	1 m / 3'3"	6.3 kg / 13.91 Ibs
YFCS 050	0.5 m / 1'8"	3.5 kg / 7.77 Ibs



Cuplock ledger/ Horizontal (Material : Q235 Spec : 48.3*3.2 mm)

Item No.	Length	Weight
YFCL 250	2.5 m / 8'2"	9.35 kg / 20.61 Ibs
YFCL 180	1.8 m / 6'	6.85 kg / 15.1 Ibs
YFCL 150	1.5 m / 4'11"	5.75 kg / 9.46 Ibs
YFCL 120	1.2 m / 4'	4.29 kg / 13.91 Ibs
YFCL 090	0.9 m / 3'	3.55 kg / 7.83 Ibs
YFCL 060	0.6 m / 2'	2.47 kg / 5.45 Ibs



Cuplock diagonal brace

Material : Q235 Spec : 48.3*3.2 mm

Item No.	Dimensions	Weight
YFCD 1518	1.5*1.8 m	8.25 kg / 18.19 Ibs
YFCD 1525	1.5*2.5 m	9.99 kg / 22.02 Ibs
YFCD 2018	2*1.8 m	9.31 kg / 20.52 Ibs
YFCD 2025	2*2.5 m	10.86 kg / 23.94 Ibs



Cuplock intermediate transom

Material : Q235 Spec : 48.3*3.2 mm

Item No.	Length	Weight
YFCIT 250	2.5 m / 8'2"	11.82 kg / 26.07 Ibs
YFCIT 180	1.8 m / 6'	8.29 kg / 18.28 Ibs
YFCIT 150	1.3 m / 4'3"	6.48 kg / 14.29 Ibs
YFCIT 120	1.2 m / 4'	5.98 kg / 13.18 Ibs
YFCIT 090	0.795 m / 2'7"	4.67 kg / 10.3 Ibs
YFCIT 060	0.565 m / 1'10"	3.83 kg / 8.44 Ibs



Cuplock scaffolding accessories



Double ledger



Board bracket



spigot connector



top cup

Material : Ductile casted iron

Weight : 0.43-0.45kg

Finsh : HDG, nature



bottom cup

Material : Q235 steel Pressed Carbon

Weight : 0.2kg

Finsh : HDG, nature



Ledger blade

Material : #35Drop Forged

Weight : 0.2-0.25kg

Finsh : HDG, natur

QUICK LOCK SCAFFOLDING SYSTEM



Standard : Material : Q235 **Finishing :** Painted
Quick lock standard/ vertical (Spec : 48.3*3.25 mm)

Item No.	Length	Weight
YFQLQ 300	3 m	17.6 kg
YFQLS 240	2.4 m	13.82 kg
YFQLS 180	1.8 m	10.52 kg
YFQLS 120	1.2 m	7.31 kg
YFQLS 090	0.9 m	5.67 kg
YFQLS 060	0.6 m	3.92 kg



Quick lock ledger/ Horizontal (Spec : 48.3*3 mm)

Item No.	Length	Weight
YFQLL 240	2.4 m	9.93 kg
YFQLL 180	1.8 m	7.63 kg
YFQLL 180	1.5 m	6.48 kg
YFQLL 120	1.2 m	5.32 kg
YFQLL 090	0.9 m	4.17 kg
YFQLL 060	0.6 m	3.02 kg



Quick lock scaffolding accessories



Coupler connected



Adapter plug

SCAFFOLDING PLANK

Size : 0.5m to 4m (other sizes are available on request)

Material : Q195 & Q235 Steel Strip **Surface treatment :** Pre- galvanized or hot dip galvanized

Standard : EN 12811-1 : 2003, EN1004 : 2004 ; AS/NZS1577 : 2013

Steel plank/ board/ platform

Item No.	Width×Height×Thickness×Lenght	Weight
YFSP 2101	210*45*1.2*1000 mm	3.6 kg
YFSP 2102	210*45*1.2*2000 mm	7.0 kg
YFSP 2103	210*45*1.2*3000 mm	10.4 kg
YFSP 2104	210*45*1.2*4000 mm	13.8 kg
YFSP 2401	240*45*1.2*1000 mm	4 kg
YFSP 2402	240*45*1.2*2000 mm	7.7 kg
YFSP 2501	250*45*1.2*1000 mm	4.2 kg
YFSP 2502	250*45*1.2*2000 mm	8.1 kg

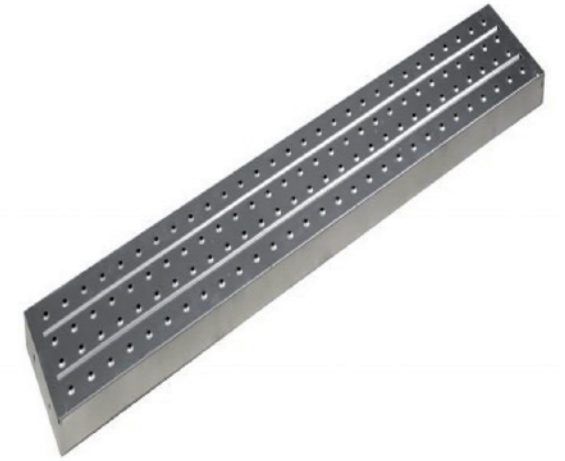

Item No.	Width×Height×Thickness×Lenght	Weight
YFSP 2201	225*38*1.5*1000 mm	4.5 kg
YFSP 2202	225*38*1.5*2000 mm	8.7 kg
YFSP 2203	225*38*1.5*3000 mm	13 kg
YFSP 2204	225*38*1.5*4000 mm	17.2 kg

Item No.	Width×Height×Thickness×Lenght	Weight
YFSP 2301	230*63*1.8*540 mm	308 kg
YFSP 2302	230*63*1.8*740 mm	5 kg
YFSP 2303	230*63*1.8*1030 mm	6.6 kg
YFSP 2304	230*63*1.8*1250 mm	7.9 kg
YFSP 2305	230*63*1.8*1810 mm	11.6 kg
YFSP 2306	230*63*1.8*2420 mm	15 kg
YFSP 2307	230*63*1.8*3070 mm	18.7 kg



Catwalk/ Steel plank with hook

Item No.	Width×Height×Thickness×Lenght	Weight
YFSPH 2101	210*45*1.5*1800 mm	8.8 kg
YFSPH 2102	210*45*1.5*2000 mm	9.7 kg
YFSPH 2401	240*45*1.5*1200 mm	6.6 kg
YFSPH 2402	240*45*1.5*1500 mm	8.1 kg
YFSPH 2501	250*50*1.5*1800 mm	10.5 kg
YFSPH 2502	250*50*1.5*2000 mm	11.4 kg
YFSPH 4201	420*45*1.2*1500 mm	11.4 kg
YFSPH 4801	480*45*1.2*1500 mm	12.7 kg
YFSPH 5001	500*50*1.2*1800 mm	16.2 kg



STEEL PROP / SHORING POST

Material : Q235 Steel Pipe **Standard :** EN1065 : 1998

Finish : Electro-galvanized, Pre-galvanized, Hot dipped galvanized, Painted, Powder-coated

Light duty prop - Spanish Prop (Wall Thickness : 1.4-2.5 mm)

Min Height	Max Height	Inner Tube	Outer Tube
1.6 m	3 m	40 mm	48 mm
0.8 m	1.4 m	40 mm	48 mm
1.8 m	3.2 m	40 mm	48 mm
2 m	3.6 m	40 mm	48 mm
2.2 m	4 m	40 mm	48 mm



Tripod



Sleeve



Fork Head



Square & flower Plate

Light duty prop - Italian Prop (Wall Thickness : 1.4-2.75 mm)

Min Height	Max Height	Inner Tube	Outer Tube
1.6 m	3 m	48 mm	56 mm
1.8 m	3.2 m	48 mm	56 mm
2 m	3.6 m	48 mm	56 mm
2.2 m	4 m	48 mm	56 mm



Prop Nuts

Heavy duty prop- Middle East prop (Wall Thickness : 1.4- 4 mm)

Min Height	Max Height	Inner Tube	Outer Tube
1.7 m	3 m	48 mm	60 mm
1.8 m	3.2 m	48 mm	60 mm
2 m	3.6 m	48 mm	60 mm
2.2 m	4 m	48 mm	60 mm
3 m	5 m	48 mm	60 mm



Prop Pins

Push - Pull Prop / Triangle prop (Wall Thickness : 1.4- 4 mm)

Min Height	Max Height	Inner Tube	Outer Tube
1.6 m	2.9 m	48 mm	60 mm
1.8 m	3.2 m	48 mm	60 mm
2 m	3.6 m	48 mm	60 mm
2.2 m	4.1 m	48 mm	60 mm
3 m	5 m	48 mm	60 mm

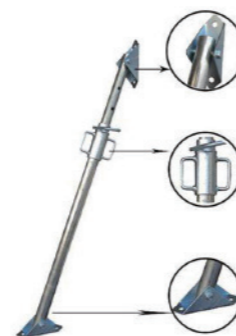

ADJUSTABLE JACK BASE AND U HEAD

Material : Q235 Steel / 20 # Steel **Standard:** EN74-1; AS/NZS1576.2:2009

Surface : Electro-galvanized, Hot dipped galvanized

Jack Base

Type	Specification	Base Plate Size
Solid	30*400 mm	120*120*4 mm
Solid	30*600 mm	120*120*4 mm
Solid	32*400 mm	120*120*4 mm
Solid	32*600 mm	120*120*4 mm
Solid	34*400 mm	120*120*4 mm
Solid	34*600 mm	150*150*5 mm
Hollow	38*4*600 mm	150*150*5 mm
Hollow	38*4*660 mm	150*150*5 mm
Hollow	38*4*760 mm	150*150*5 mm
Hollow	48*4*600 mm	150*150*5 mm
Hollow	48*4*900 mm	150*150*5 mm



U head Jack

Type	Specification	U Base Plate Size
Solid	30*400 mm	150*150*50*4 mm
Solid	30*600 mm	150*120*50*4 mm
Solid	32*400 mm	120*120*50*4 mm
Solid	32*600 mm	150*120*50*4 mm
Solid	34*400 mm	120*120*50*4 mm
Solid	34*600 mm	150*120*50*4 mm
Hollow	38*4*600 mm	150*150*50*5 mm
Hollow	38*4*660 mm	180*150*80*6 mm
Hollow	38*4*760 mm	165*150*50*5 mm
Hollow	48*4*600 mm	150*150*50*8 mm
Hollow	48*4*900 mm	200*200*50*8 mm



Jack Nut: Casted or forged Finish: Original ,Electro Galvanized,HDG
Diameter: 30/32/34/38/48 mm



SCAFFOLDING COUPLER

Standard : EN 74-1:2005; EN 74-2:2009; AS/NZS 1576.2:2009; BS 1139-2.2:2009+A1:2015; ANSI/SSFI SC100-5/05; GB 15831-2006; GB 24910-2010.



FORMWORK ACCESSORIES

Formwork accessories



Hexagonal long nut
0.21kg



Water stop
0.48kg



Tie nut
0.9kg



Tie nut
0.6kg



Wing nut
0.28kg



Washer plate
0.57kg



Steel cone
0.615kg



U-clip
12mm/16mm
0.16kg/0.5kg



Formwork spring clamp
0.31kg/0.31kg
0.41kg/0.44kg



Aluminum formwork clamp
0.56kg/0.58kg/0.6kg



Wedge clamps
1.0kg



Panel Formwork
4.3kg

TIMBER FORMWORK

Film faced plywood

Film faced plywood is also called as phenolic plywood, shutter formwork, phenolic plywood, Applied for all kinds of civil or commercial buildings, such as Decoration, furniture bridges, European style buildings, hospital, gas stations, etc.

Size	915*1830mm,1220mm*2440mm,1250*2500mm,1525 mm*3500 mm, or ther sizes as client's request
Thickness	10-40 mm
Glue	MR /Melamine/ WBP
Core	Poplar, Birch, Combi, Hardwood, Bamboo, Eucalyptus
Moisture	To be 9%-14% at time of shipment.
Grade	A, B, AB, C
Package	Inter packing: 0.20mm plastic bag. Outer packing: pallets are covered with plywood or carton and then steel for strength.
Capacity	20GP: 8 pallets/21~24cbm 40GP: 16 pallets/48cbm 40HP: 18 pallets/50~59cbm
Face/Back	Black film, Brown film , Yellow film or wear - Mesh film
Certificate	CE, FSC, ISO9001, ISO14001,CARB,F17

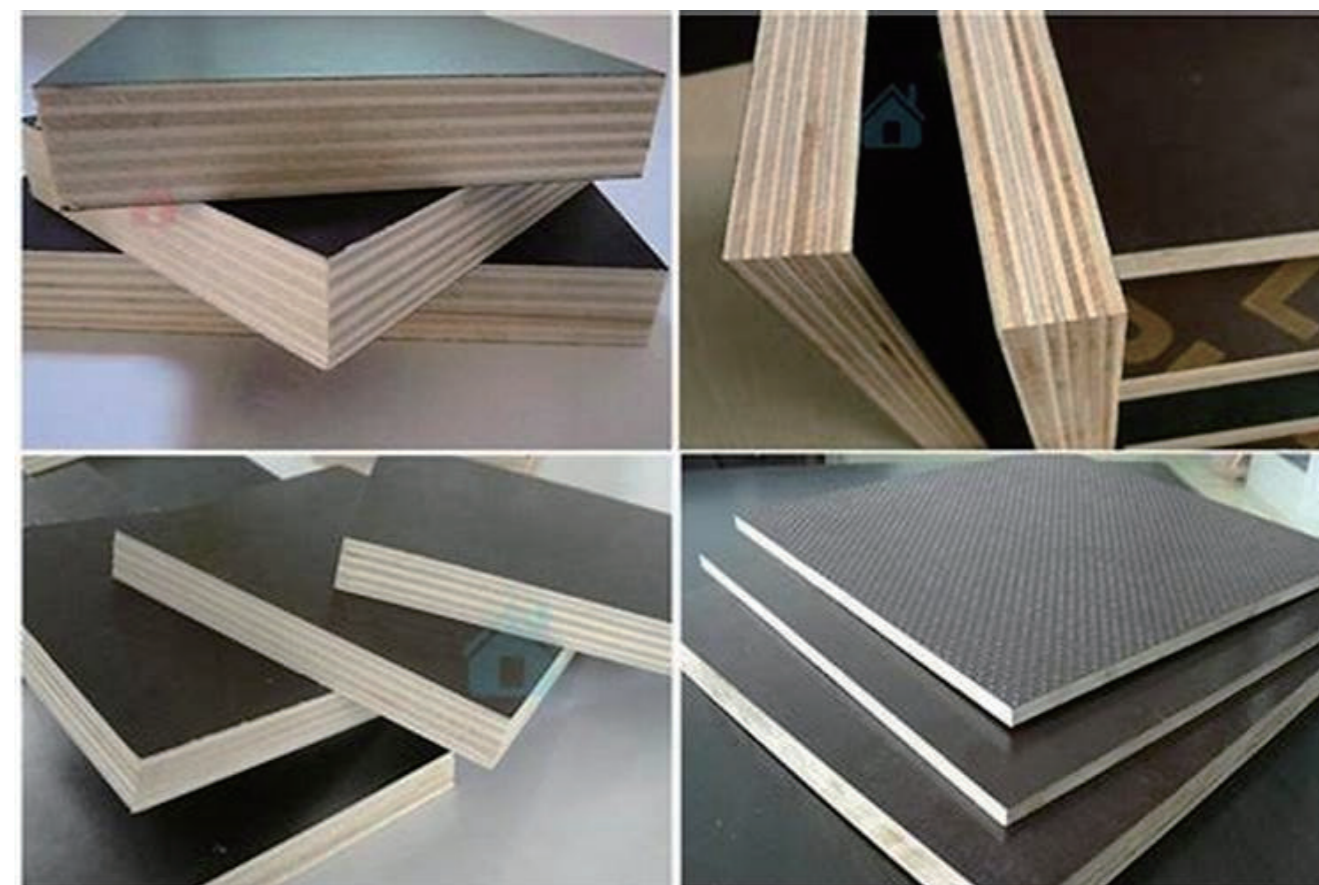

H BEAM FORMWORK

Timber beam



H20 construction timber beam:

- 1.H20 construction timber beam widely applied to concrete formwork construction,used together with prop,tripod,forkhead.
- 2.Flange is made of spruce or radiata pin, finger-jointed into the web.Web is 3-layer plywood.
- 3.H20 construction timber beam is waterproof using a water-repellent color glaze.
- 4.The length of h20 construction timber beam can be 2.45m, 2.9m, 3.3m, 3.9m, 4.9m and 5.9m. Max length is 6m.
- 5.The end of beam can be sealed to protect moisture, reduce damage, increase service life.

Surface Treatment	Yellow painting, waterproof
Glue	WBP
Size	Length:3000-5900mm, Width: 200mm Thickness: 80mm
Flange	Material: Timber, LVL,Plywood
	Size: 40*80*3000~5900mm
Web	Material: Timber, LVL,Plywood
	Size:27/30mm*135mm*3000~5000mm
Usage	Construction,Concrete Shuttering,Formwork Support
Formaldehyde Emission Standards	E0
Moisture Content	Below 12%
Density	600kgs/cubic meter
End Cover	Red plastic wrap, waterproof
Certificate	CE,CARB,FSC, ISO9001;



ALUMINUM BEAM



Aluminium alloy	6063,6061,6005,6463,6082,7075etc
Temper	T3-T8
Thickness	General profiles thickness: 0.8- 5.0 mm
	Anodized protection thickness: 8 - 25 um
	Powder coating color thickness: 60 -120 um
Shape	Square, flat, round, hollow, oval, triangle, U-profiles,L-profiles,
	T-profiles, H-profiles, custom
Finishing	Mill, anodized, powder coated, electrophoresis, wood grain, timber,
	PVDF paint, polish, brushed
Color	Metal silver, champagne, black, white, mirror, custom
Application	Windows and doors,curtain walls, glass wall, furniture, ceiling,
	Kitchen, LED strip, vehicles, motor housing, machine, tent, solar.
	Industrial profile, decoration profile
Deep Process	CNC, drilling,milling, cutting, welding, bending, assembling
Certificate and Standard	ISO9001-2008/ISO 9001:2008
	CQM Certification
	SGS, CE, BV,JIS,AS, NZS,QUALICOAT,QUOLANOD AVAILABLE

ALUMINIUM LADDER

Industry ladder

Material: Aluminum 6063-T5

Thickness: 1.2-3mm or as your requirement



Extension Ladder



Single Straight Ladder



Rope operated Extension Ladder



Multi-purpose Ladder



Dual-purpose Ladder



Single Straight Ladder



Multi-purpose Fiberglass Ladder

Household ladder



Car Wash/Work Platform



Telescopic Ladder



Step Stool



Aluminum Stair



Double Side Telescopic Ladder



A Type Ladder



A Type Fiberglass Ladder



Household Step Ladder

ALUMINUM TOWER

750 single wide aluminum tower



Single wide aluminum tower scope of use:

Single wide aluminum tower Can be used for roadside signs renovation, narrow indoor space, such as indoor, subway stations, corridors, tunnels, channels, reservoirs, buildings, halls, elevators and so on

Specification

Width	Frame height	Tower height	Material
750	2000	3000	Aluminum 6061-T6
750	2000	5000	
750	2000	7000	
750	2000	9000	
750	2000	11000	

The width of the single wide aluminum tower is 0.75m, the length is 2.0 m, 2.5m and 3.0 m, the carrying capacity of the whole frame (including its own weight) is 750kg, the bearing weight of each board is 230kg, the bearing weight of casters is 900kg, and the feet can be adjusted to 40cm. The maximum construction height is 12m.

1350 double wide aluminum tower



The "double wide aluminum alloy scaffolding" refers to the frame of the upper and lower spacing of 46cm is a kind of aluminum alloy scaffolding. General market, this kind of aluminum alloy scaffolding can also be divided into: double width vertical ladder type aluminum alloy scaffolding, double width 70 degrees inclined ladder type aluminum alloy scaffolding and double width 45 degrees inclined ladder type aluminum alloy scaffolding these three categories.

Specification

Width	Frame height	Tower height	Material
1350	2000	3000	Aluminum 6061-T6
1350	2000	5000	
1350	2000	7000	
1350	2000	9000	
1350	2000	11000	
1350	2000	13000	

All Staff of Tianjin Youfa International Trade Co., Ltd



Tianjin Youfa Steel Pipe Group Culture

YOUFA'S MISSION: 友发的使命

TO LET ITS EMPLOYEES GROW HAPPILY; 让员工幸福成长

TO PROMOTE THE HEALTHY DEVELOPMENT OF THE INDUSTRY. 促行业健康发展

YOUFA'S VISION: 友发的愿景

TO BECOME A GLOBAL EXPERT OF PIPELINE SYSTEM. 做全球管道系统专家

YOUFA'S CORE VALUE: 友发核心价值观

TO BE WIN-WIN WITH INTEGRITY POLICY; 共赢互利信为本

TO ADVANCE TOGETHER WITH VIRTUE FIRST. 同心并进德为先

YOUFA'S SPIRIT: 友发的精神

TO DISCIPLINE OURSELVES, BENEFIT OTHERS; 律己利他

COOPERATE AND FORGE AHEAD. 合作进取